

KINGS LANGLEY

Public Realm Strategy



ARUP

Executive Summary

This Public Realm Strategy builds upon the great green spaces, community facilities and retail destinations of Kings Langley, and sets out principles on creating a more pedestrian friendly high street to improve the well-being of the village, whilst also bolstering the local economy and encouraging active transport. The key moves of the strategy are outlined below:

'Weave' together the high street and existing pedestrian routes

Currently the busy A4251 creates severance affecting the whole village, causing poor east to west pedestrian connections. Improving pedestrian access along the whole length of the high street will allow destinations and pedestrian routes within the wider village to be connected. This will enable more trips via walking and cycling to the high street and wider destinations. Potential interventions include wider pavements to remove pinch points, resurfacing pavements and additional pedestrian priority crossings.

Create three squares along the high street

Pedestrian and vehicle movements currently conflict at road junctions along the high street, causing safety and access issues. Creating three new squares at key junctions will calm through traffic, offer greater pedestrian priority at road crossings and provide space for local businesses to spill out. Potential interventions could include: removing parking, high quality resurfacing and creating a raised table. One of these squares, market square, will feature as the main square which hosts the existing market, with potential for increased capacity.

Redistribute parking

Vehicles and parking currently dominate the high street, leaving minimal space for pedestrians. Removal of 12 on-street parking spaces would provide space to remove pinch points and encourage dwell time to support local businesses. The strategy demonstrates how these could be re-provided in the existing Nap car park. Alternative on-street parking management methods are recommended to ensure the most efficient use of on-street parking to support local businesses.



Study Purpose & Context

Arup was commissioned in November 2019 by Kings Langley Parish Council to develop an outline public realm strategy for the High Street in the village of Kings Langley.

The study provides a brief analysis of historic character and evolution, then undertakes analysis of current conditions in terms of movement, pedestrian connectivity, destinations and access. This is followed by a Strengths, Weaknesses and Threats or SWOT analysis before developing outline proposals to respond to the issues identified.

Context

- The long, broad High Street which is the focus of this study is characterised by many attractive buildings from the 16th – 19th centuries, often of local red brick, coloured render and clay tile, and a number of distinctive landmark buildings such as the 14th century flint and Totternhoe stone Church of All Saints and the adjacent Regency villa of Blue Court, plus the two public houses.
- A thriving range of independent businesses and food and beverage offerings have grown up in the High Street in recent years, along with a monthly local produce market, all of which add vibrancy and interest to the street scene.
- The village faces issues through being a strategic commuter route into Watford and Greater North London, and for connections to the M25 and A41 bypass immediately south of the village.
- The village also has a number of businesses with significant need for car parking, all of which create congestion and tensions between accommodating this and rush hour traffic, and spaces for people and dwell time/healthier urban environments.

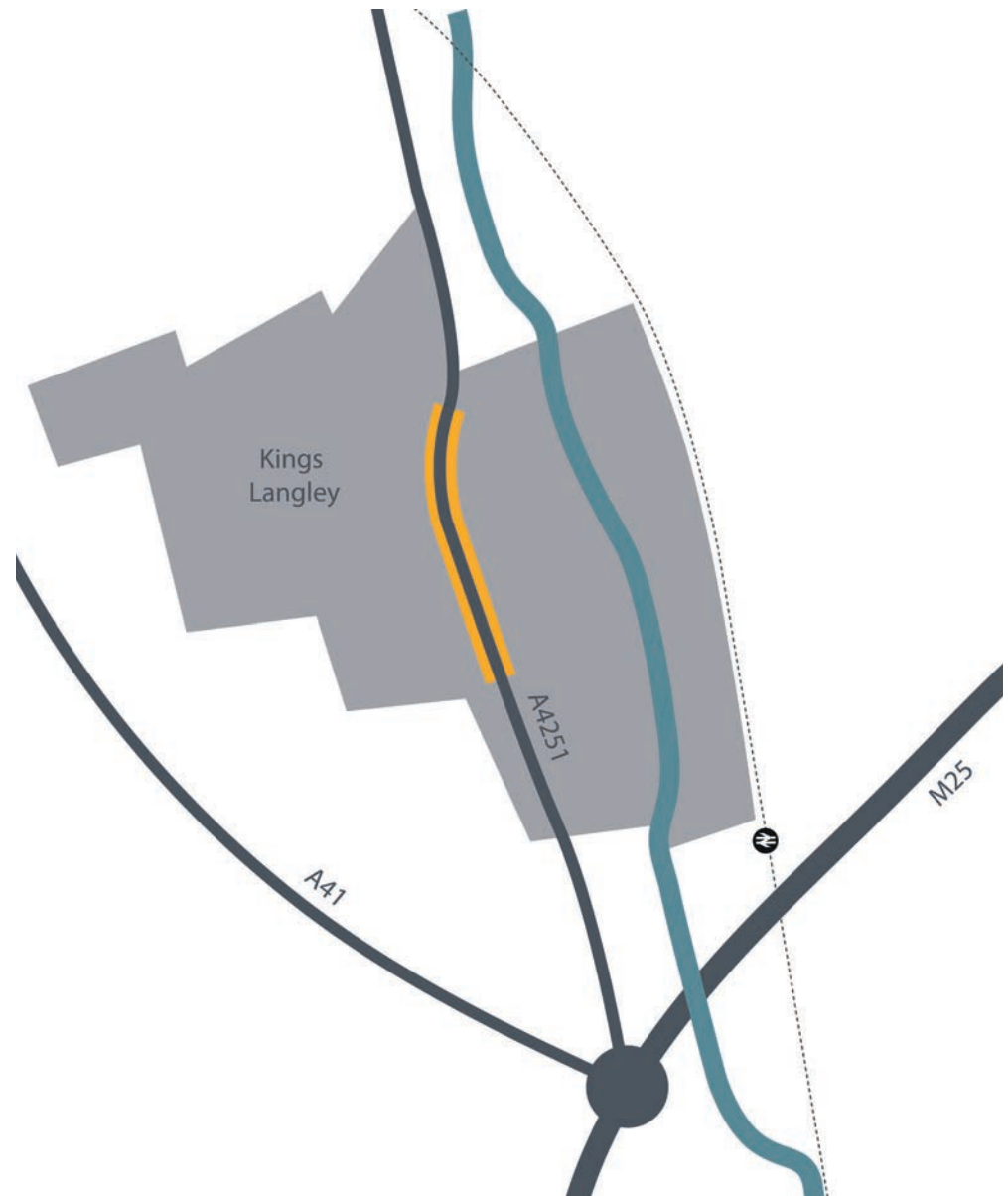

Historical context

- Kings Langley, in the middle-lower Gade Valley, is a fine example of a relatively large Hertfordshire village of ancient origin.
- Dating back at least to Domesday, the village was originally centred upon two key aspects – the river and associated mills for flour (and, much later, paper) and the Royal deer park and palace and Dominican Friary at the top of Langley Hill, dating from when Queen Eleanor purchased the manor and much of 'Langelei' (or 'Long Lea') from the Abbot of St Albans in 1276.
- In early times, what is currently the High Street had little significance as a transport route, as much of the activity in the village was originally centred further east on Green Lane, Dronken Lane and 'The Wick' around the mill and Waterside, and to the west around the palace and park.
- In the medieval period the site of the present High Street was a market place ('New Chepinge'), with the manor house immediately west and the church of All Saints to the south, opposite the gates to the royal 'Great Park' and the associated medieval route 'The Drift' linking the royal hunting lodge of Little London in the Home Park by the river with the palace at the top of Le Corte Hill (now Langley Hill).
- The route of the current High Street originally terminated abruptly at the junction of Vicarage Lane with The Nap, with Glebe or Vicarage lands beyond. The road did not form a continuous route until a link between Vicarage Lane and Rectory Lane was constructed by the Sparrows Herne Turnpike Trust in the 18th century. With this in place, along with the construction of the Grand Union Canal in the valley and later the London and Northwestern Railway between London and Birmingham, the scene was set for Kings Langley to evolve into the village of today.

Source: Munby, L and the Kings Langley WEA, 1969, *The History of Kings Langley*, and Hastie, S and Spain D, 1991, *Kings Langley – A Hertfordshire Village*



Kings Langley High Street Pre 1914, Kings Langley Local History and Museum Society

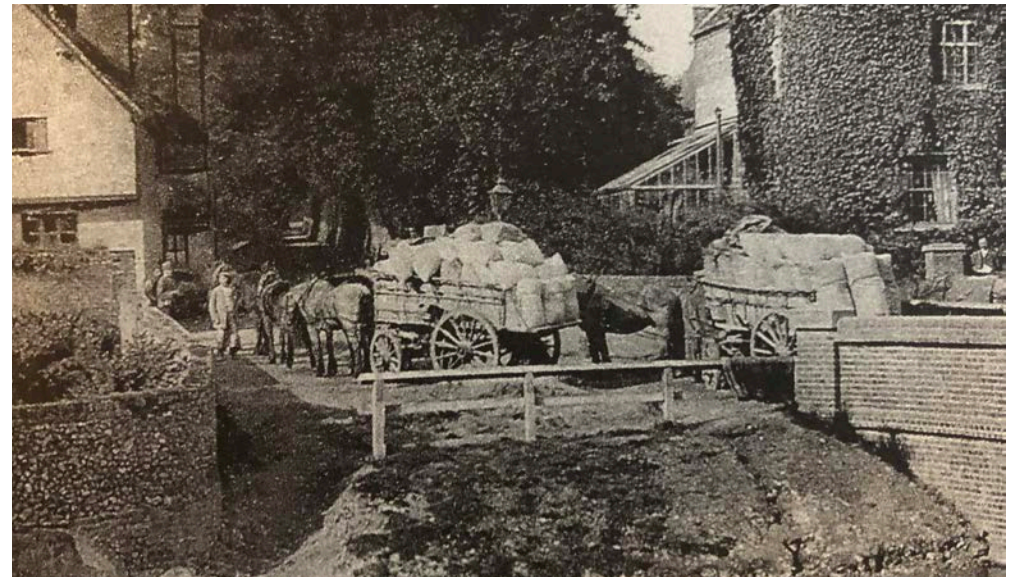

Tooveys Mill Pre 1900, Kings Langley Local History and Museum Society

Current Condition: Movement



- Busy A4251 (the High Street) creates severance affecting the whole village
- Poor east to west pedestrian connectivity due to lack of pedestrian crossing points, level change and hitching rails along high street
- Pedestrian/ vehicle movement conflicts and sight line issues at junctions
- Vehicles have priority over pedestrians along the length of the high street

Key

Primary Movement Corridor

Secondary Movement Corridor

Pedestrian only corridor

Pedestrian Crossings

Pedestrian/ Vehicle conflict zones

Not to scale

Current Condition: Destinations



- Multiple green spaces, community facilities and retail destinations provide the ingredients for a vibrant village centre
- However destinations, including retail units, are dispersed and poorly connected due to barriers to pedestrian movement previously discussed
- Improving connectivity to high quality green spaces would encourage greener and more tranquil spaces to be used offering well-being benefits
- Bus stops along high street length could be rationalised

Key

-  Active Frontage: Retail + Food outlets
-  Key green space
-  Bus stop
-  Community Facility

Current Condition: Access



- Western high street edge conditions provide barrier to inclusive access: level changes and hitching rails
- Level change between 200 - 500mm
- Some bus stops not accessible due to level changes
- Accessible road crossing points limited to two pelican crossings (further studies required to assess whether they meet current accessibility standards)
- Key parts of the High Street have equal access issues, including the market area

Key

 Hitching Railings

 Step level change + no

 Hitching Railings

 Grass Verge

 Level Change + Hitching Railings

 Accessible Routes

Current Condition: SWOT

Strengths and Opportunities



Heritage: Historic buildings provide character and sense of place, with opportunity to improve their setting



Compact green village: Opportunity for increasing walking to the high street via green links



Street width: Opportunity to increase cafe and retail spill out to activate the street



Popular regular market with potential to increase capacity/regularity

Weaknesses and Threats



Level changes: Due to valley side topography pedestrian movement and accessible routes are limited



Significant traffic: Impact on pedestrian safety, health and creating severance



Car domination: significant amounts of high street car parking limits pedestrian experience

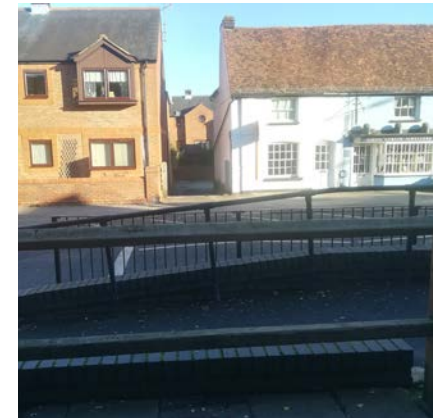

Street clutter: Significant barriers limit movement and mixed materiality affects street aesthetic

Principles

1. 'Weave': high street and green link

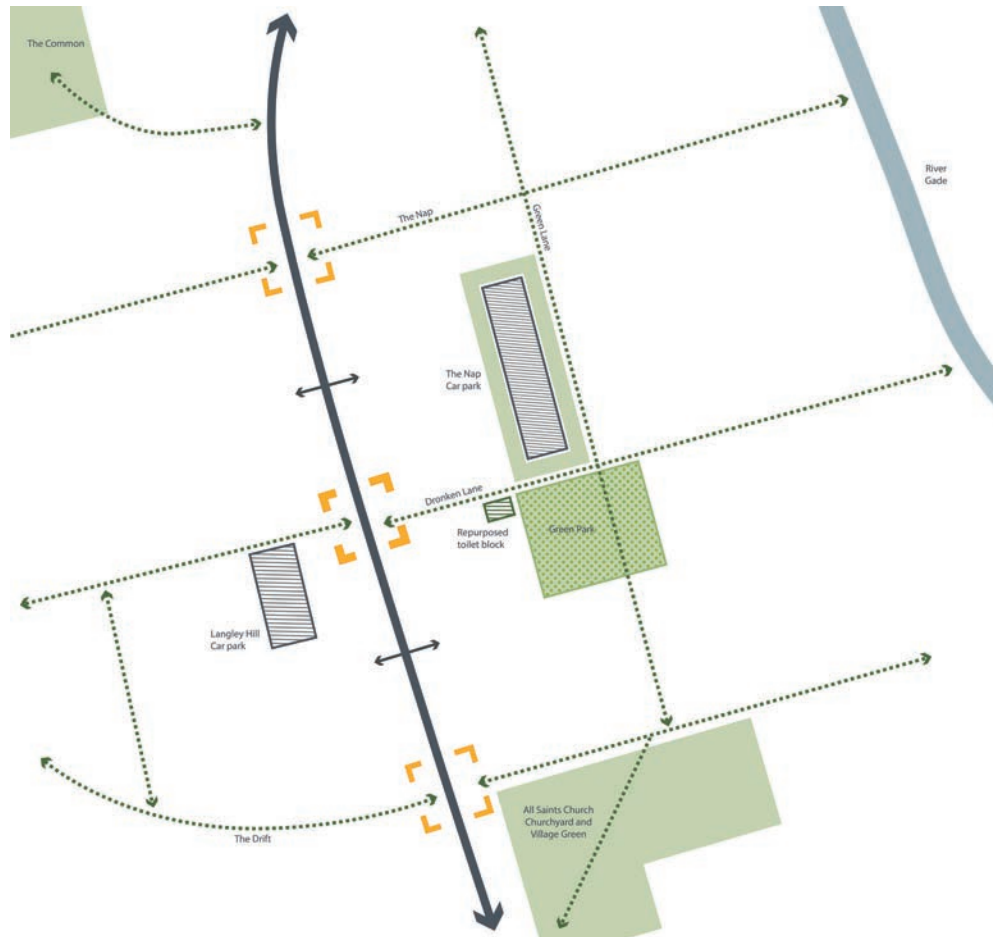

Key



- Improving the connection between the **high street** and existing **green pedestrian routes** will enable more trips via walking or cycling to the high street and green spaces
- **Pedestrian friendly** high street to connect key destinations and pedestrian routes. Potential interventions include: wider pavements, active frontages, additional pedestrian priority crossings
- Opportunities to improve **key green links** and nearby **green spaces** to the high street to enhance gateways, offering welcoming arrival to visitors and provide enhanced recreation in most visited green spaces
- Key opportunity: Dronken Lane and Green Park Link.

Principles

2. Three Squares: Focal Points

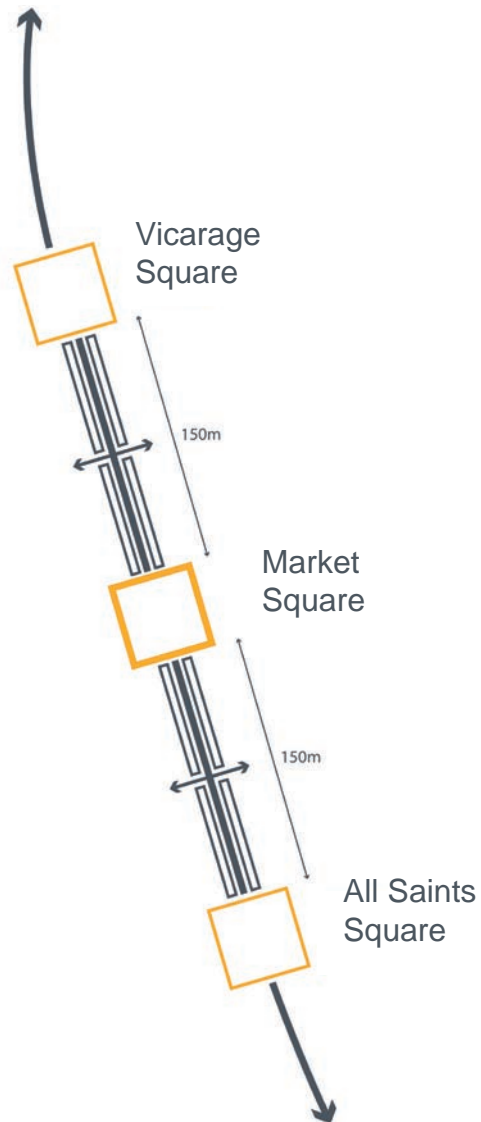

Squares: Three squares at the three key intersections along the high street will provide focal points and greater primacy to pedestrians, as well as calming through traffic.

Potential interventions:

- Removing parking enhances the pedestrian experience and offers additional spill out for existing retail and food businesses
- Raised table, tightened junctions and high quality resurfacing
- Resurfacing with high quality stone provide visual cues for pedestrian priority

Streets: Between the squares 'streets' retain car parking for direct access to retail and secondary crossing points for pedestrians.

Potential interventions:

- Resurfacing, de-cluttering and simplifying materials e.g. types of barriers/ railings

Three Squares: Existing Conditions



All Saints Square

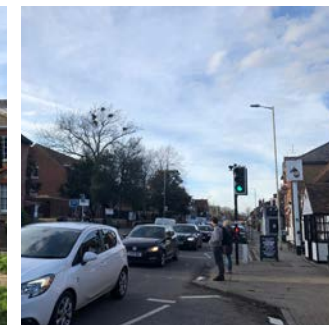

Market Square



Vicarage Square

Principles

2. Square One: Market Square

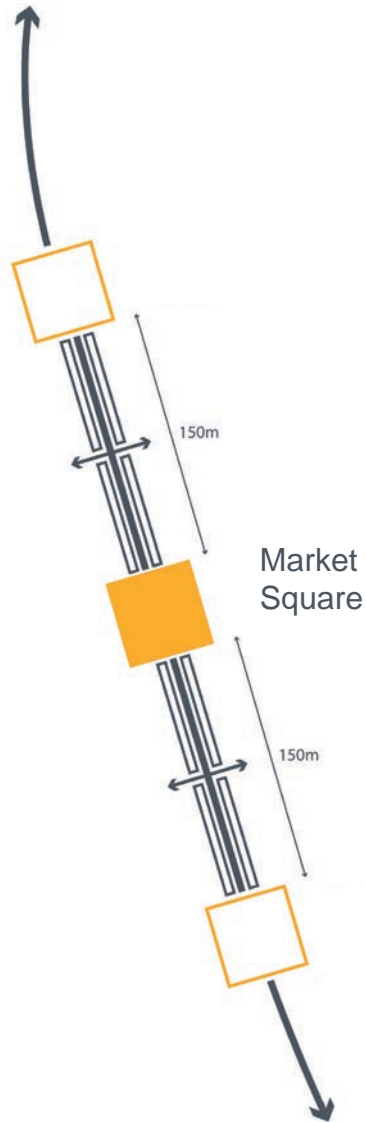

- Main focal point for the village, a central gathering space which hosts the existing market
- Existing bus stop and car parking removed to extend pedestrian space and allow further spill out from local businesses
- Frames and enhances the setting of historic buildings such as Haverfield and the Saracen's Head
- Improved gateway from Dronken Lane and Langley Hill, for visitors from village car parks
- Existing market will continue in the existing location, with potential for increased capacity

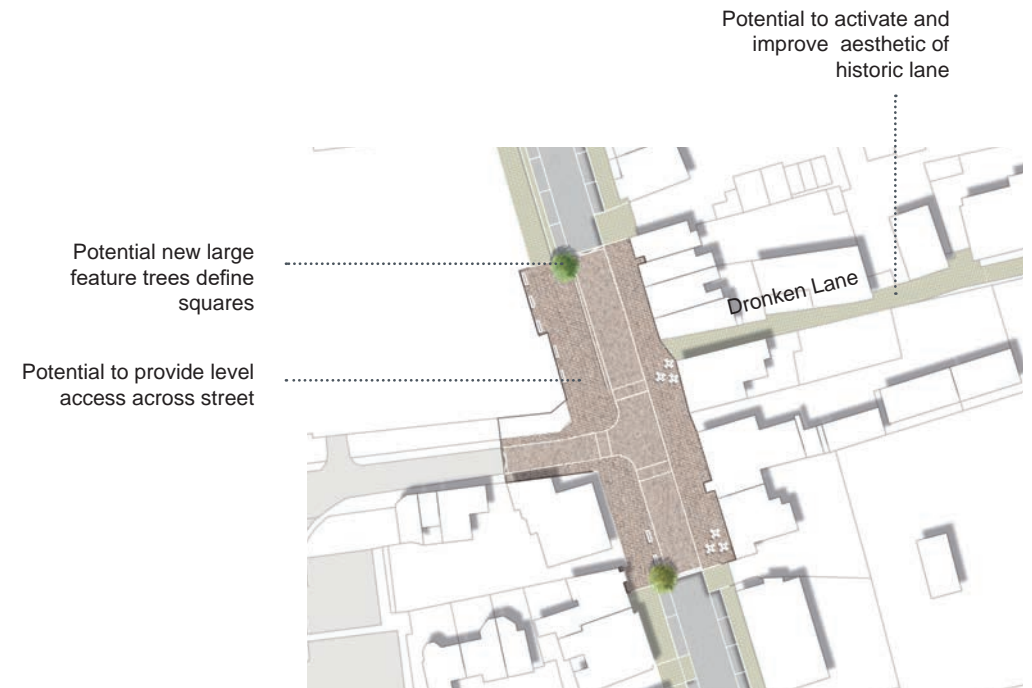





Dronken Lane Vision

Disused toilet block
reused for activating
Dronken Lane

Welcome signage
to the high street

Artwork opportunities
referencing history of
the lane along façades

Dronken Lane Vision

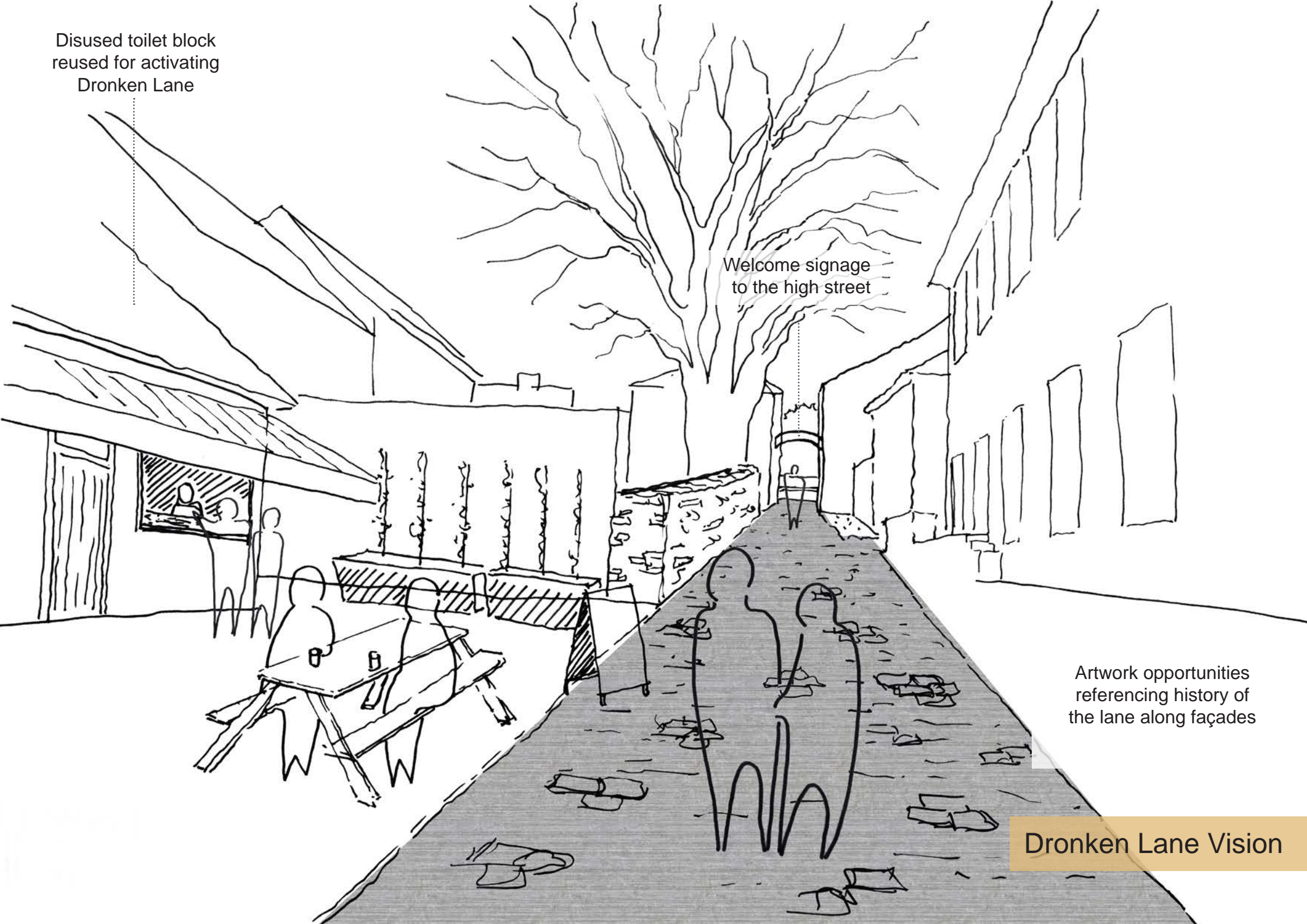

Principles

2. Square Two: All Saints Square

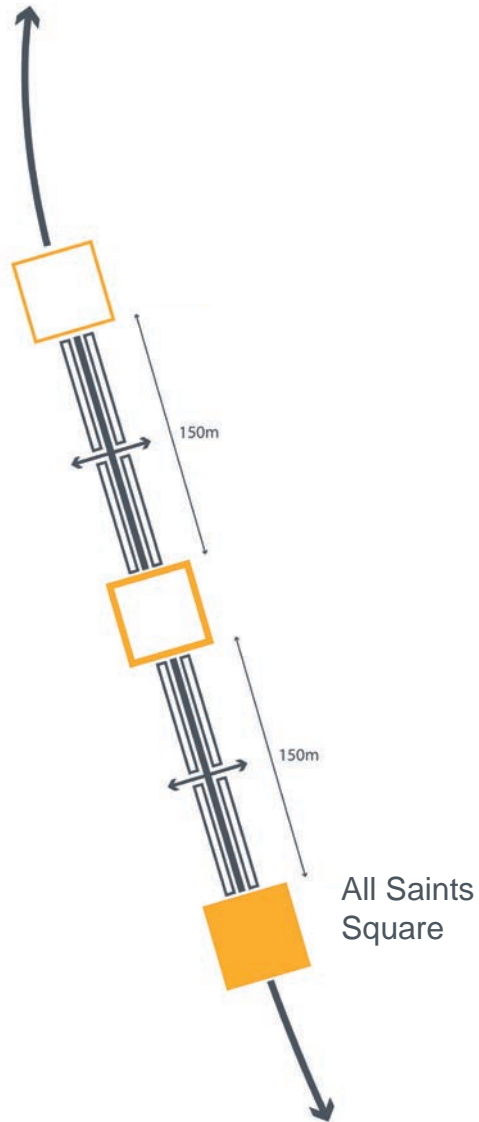

- Offers a safe pedestrian focused space, connecting All Saints Church, Rose and Crown and 'The Drift' historic footpath
- Provides an enhanced setting to the heritage asset of Blue Court
- Raised table, tightened junctions and high quality resurfacing provide visual cues for pedestrian priority
- Recommend starting a 20mph speed limit for the high street from this location

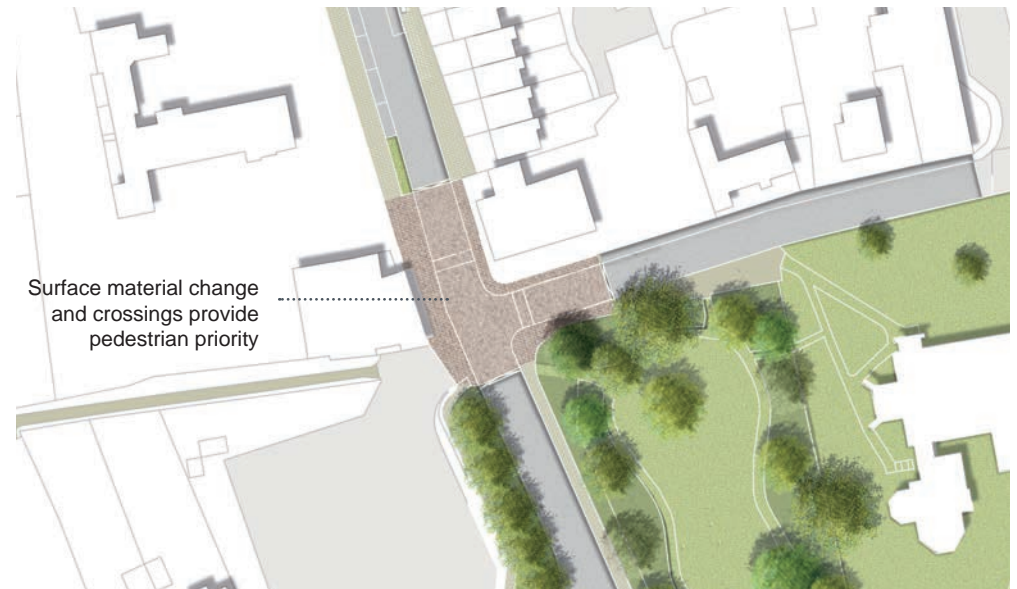



CHURCH BUILDING
1874-1878
FOR SALE
by
01442 243033

CHURCH LANE

THE
ROSE & CROWN



20
ZONE



All Saints Square

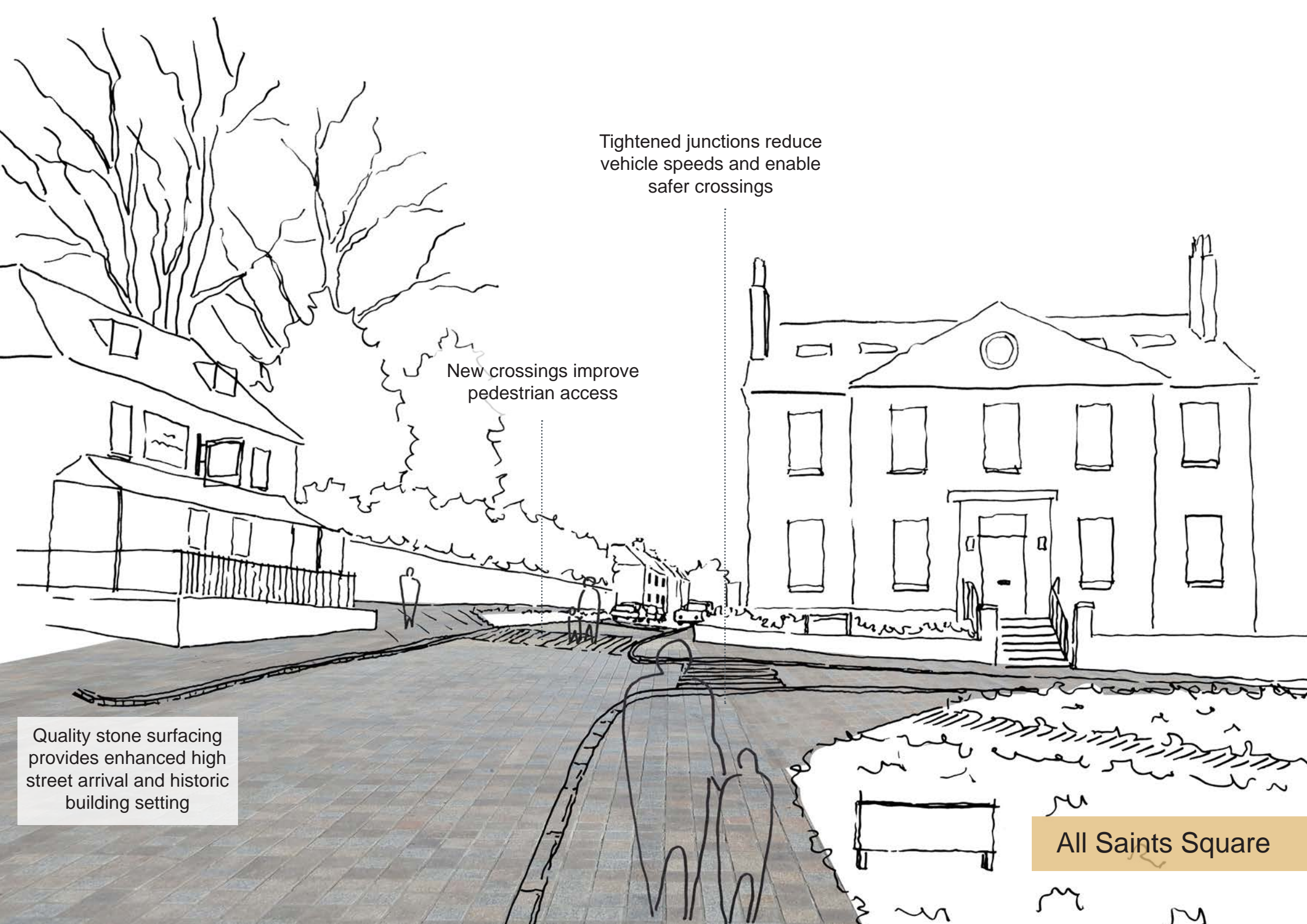

Tightened junctions reduce vehicle speeds and enable safer crossings

New crossings improve pedestrian access

Quality stone surfacing provides enhanced high street arrival and historic building setting

All Saints Square

Principles

2. Square Three: Vicarage Square

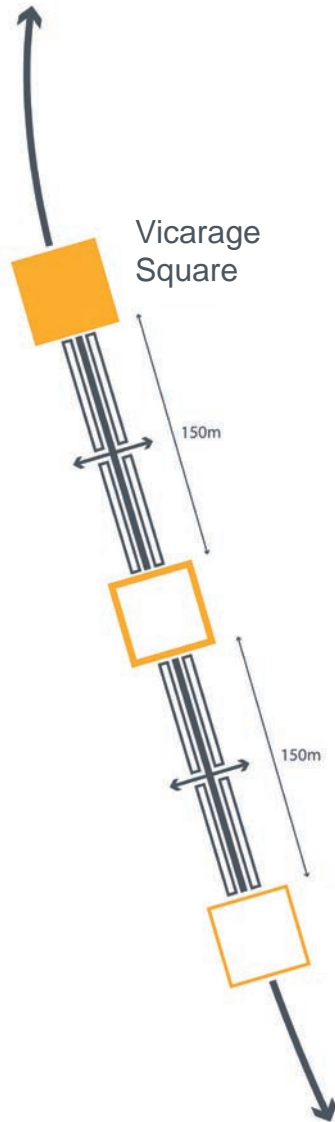

- Offers a safe pedestrian focused space at the busy intersection of A4251 and The Nap
- Activation via additional spill out space for cafés and retail improve vitality and local businesses
- Raised table, tightened junctions and high quality resurfacing provide visual cues for pedestrian priority
- Resolves levels at the loading bay by Vicarage Lane



Principles

3. Car Parking: Redistribute

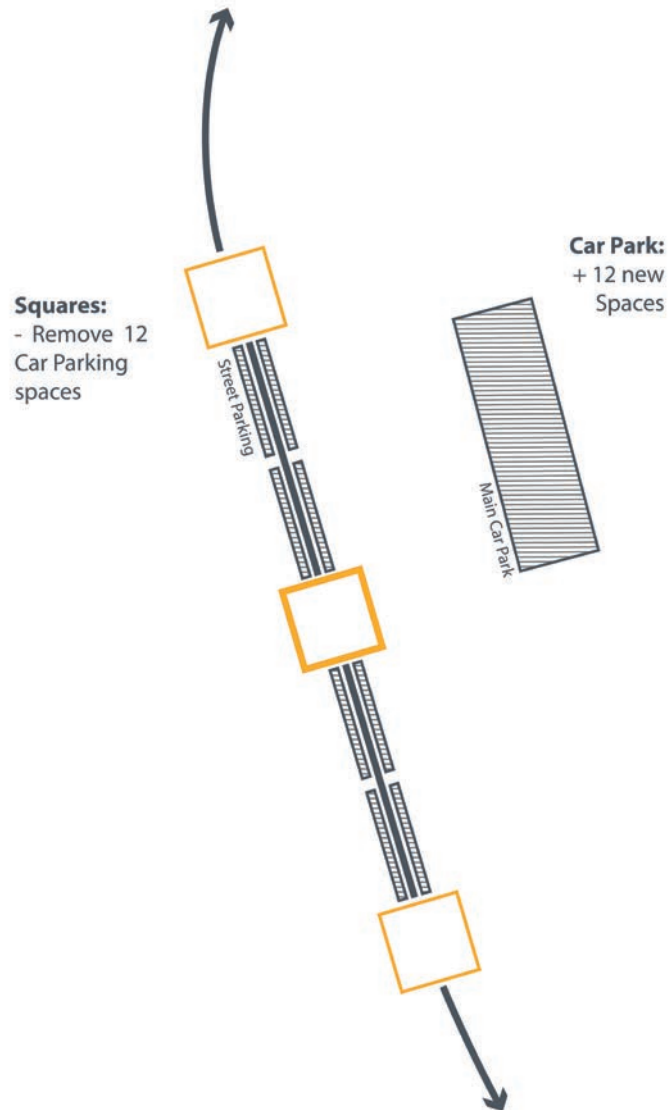

- On street parking along the high street maintained between squares
- 12 car parking spaces removed within squares re-provided in the existing The Nap car park. These could be accommodated as part of a tidy up exercise of the existing informal road edge. These additional parking spaces could also be created as reinforced grass areas.

The Nap Car Park Proposals



Principles

3. Car Parking (Advice from Transport Planner)

- Enforcement – free parking or first 1-2 hours free makes enforcement difficult to do in terms of resources and costs, as it requires two visits at specific times etc, so it is difficult to manage. Overall enforcement should be possible as part of Dacorum’s wider parking enforcement programme, and with using modest sliding scale of charges from the outset of a visit to the High Street, as per the case in Dacorum more widely. If charged parking consider options for how payment may be collected, payment via mobile phone, so don’t need to have Pay and Display machines with associated street clutter and maintenance implications. It is suggested this is discussed further between KLPC and Dacorum BC.
- Communicate and focus on the benefits that can come from using parking spaces as something else – and call it that – so not “losing parking” but gaining greenery, seating, public space, better movement and circulation etc – the language of positivity. The two steps – reconfiguration of aspects of the High Street for these benefits, and parking enforcement – should be considered hand in hand to be most effective.
- Further baseline data would be useful – who uses the space now for what and for how long – does not have to be lengthy survey as observations reveal a lot. From other work our transport planner has done, high street retailers could also be involved in this data gathering – how do their shoppers get there etc (retailers typically over-estimate the % arriving by car and underestimate the % arriving by active modes and public transport). Try to hear the usually unheard voices such as elderly people, people with children, women etc.
- The value of trials in relation to spatial or management options (e.g. temporary design interventions before making them permanent or trial of parking charge scheme) should not be underestimated – they are low cost, quick to do, take out the fear, enable fine tuning etc. People can see the benefits rather than fear the worst.

Principles

4. Signalisation of Vicarage Lane/ Nap Junction (Advice from Transport Planner)

- Focus on the problems / what outcome is being sought rather than jumping to a potential solution – for traffic calming there could be other ways of achieving this – e.g. lower speed limits linked to design measures which passively facilitate traffic calming. This could also link to the enforcement above e.g. to prohibit parking in the loading bay to reduce the visual blind spot which contributes to traffic issues in this location.
- If it is more about reducing the risk of collision, again proposals could be trialled e.g. temporary lights for a period worthwhile for capturing data, to see what the impact might be, before committing to the expense (capital and ongoing maintenance) of permanent signals.
- Overall – It is most effective to think about all transport issues together and in parallel with the later detailed design development of the public realm strategy as they are all inter-related – it is good to involve the community bottom up in these and later stages, so they feel part of the plan, rather than being ‘top down’ imposed. This would enable a move from the traditional consultation “design and defend” model to a market research model.

Principles

5. Resolving Pinch Points

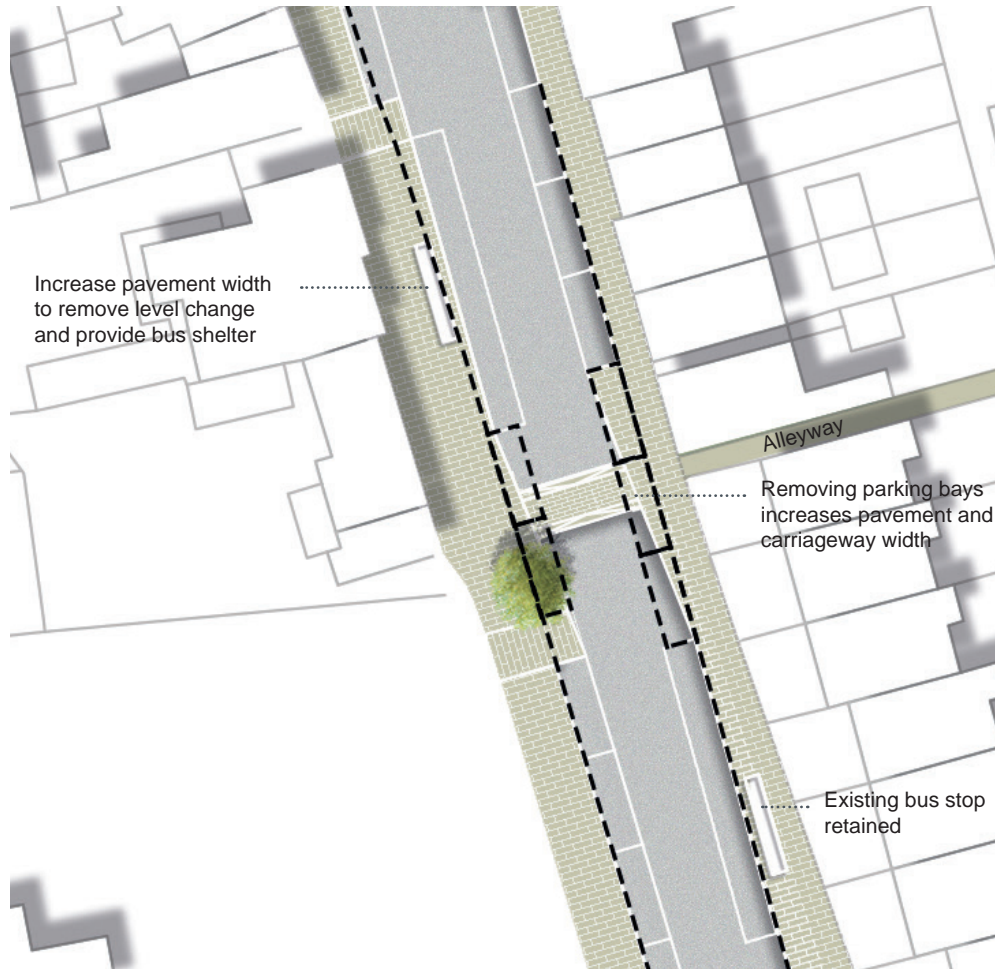

Key

- - - Existing road alignment and parking spaces

- Current pinch point along the high street near southernmost bus stop reduces carriageway widths providing safety concerns
- 5 parking spaces removed to increase carriageway widths, removing the pinch point and increasing pavement widths
- Provides the opportunity to offer additional pedestrian crossing
- Vehicles will be required to wait behind buses and not overtake.

Indicative Masterplan

Vicarage Square

Market Square

All Saints Square



The Common

Village gateway:
Signage & Rumble strip

The Nap
Car Park

Dronken Lane

Langley Hill
Car Park

All Saints
Church



Not to scale

Village gateway:
Signage & Rumble strip

Precedents



Poynton Town Centre

- Simplified and resurfaced shared space provides a free flowing low speed street
- De-cluttered street with road markings, barriers and traffic signals removed
- Widened footways and large pedestrian crossing



Altrincham Town Centre

- High quality simple stone pedestrian spaces enhance setting of historic buildings
- Reduced vehicle lane widths lowers traffic speeds



Brentford High Street Square

- Flexible space hosting weekly market
- Bespoke timber seats enable community gathering
- Feature willow tree references local river proximity

Recommendations

This Public Realm Strategy should be seen as the overarching strategy for King Langleys public realm and used as a foundation for future alterations to the high street. It builds upon the great green spaces, community facilities and retail destinations of King's Langley, and sets out 5 key principles which will join these destinations together to improve the safety, wellbeing and vibrancy of the village. Moving forward future work should take a holistic approach, with transport planning and engineering input required.

Engage

It will be essential to consult with local people and businesses to ensure the public realm meets the needs of the people and supports a sustainable social and economic model. An early public consultation event is recommended, which could include a presentation to local people of this strategy and a way of gathering feedback and insights to amend the design to the needs of the local people.

Supporting Strategies

In developing this work it has become apparent that there are a number of supporting and complimentary strategies required before any public realm improvements can be further progressed, including:

- Topographic survey (all references to levels in this strategy have been indicative)
- Utilities and services
- Parking survey (for more detail, see principle 3: car parking)

Financing

This strategy can support Kings Langley Parish Council in the process of securing funding for delivery, which explains and illustrates the aspirations for the public realm. Relevant funding streams may include Section 106, Community Infrastructure Levy, Future High Streets Fund and Highways England Environmental Designated Fund (EDF). Highways England EDF provides funding for environmental improvement works to the surroundings of A roads and Motorways. This funding comes through HE's Road Investment Strategy (RIS), which sets the funding criteria for the next 5 years. Usually this is to mitigate the negative impacts of these roads, such as the A4251 which runs through the village. The EDF theme (as per RIS 1) most likely to be relevant to Kings Langley High Street is Cultural Heritage.

Temporary Trials

Temporary trials provide a great way of testing spatial or management options, which are low cost, quick to do and enable fine tuning, before interventions are made permanent. Elements of this strategy which might benefit from temporary trials include increased pavement widths, street parking changes e.g. on-street parking charge scheme, removal of some on-street parking bays and traffic calming measures e.g. 20 mph speed limit.

It is recommended that temporary trials are aligned with a village event e.g. festival or fête, to showcase the potential benefits of the measures and maximise interest from the public. Monitoring of these trials would then provide evidence of the value of the proposed changes and strengthen the case for permanent solutions. Methods of monitoring could include pre and post installation opinion surveys to business owners and users, observational analysis, and parking surveys.

Useful references

Some useful references, evidence and case studies for the integrated public realm and traffic management approach outlined are set out in the below documents:

<https://www.sustrans.org.uk/our-blog/news/2019/november/common-myths-about-investment-in-walking-and-cycling-busted-by-research-report/>

<https://www.livingstreets.org.uk/media/3890/pedestrian-pound-2018.pdf>

<http://cidadaniaxmob.tripod.com/shoppersandhowtheytravel.pdf>

And albeit in a London specific context, the below has some transferable ideas:

<http://content.tfl.gov.uk/walking-cycling-economic-benefits-summary-pack.pdf>